



Petro Chemical Plants



Coastal Areas



Waste water Treatment



Food Processing

Combat Excessive Moisture and Corrosion in Hazardous and Hostile Environments

- Non-metallic controls for Class I, Division 2, Groups A, B, C, D locations and corrosive areas.
- Constructed of rugged polyester resin and gasketed for NEMA 4X hose down protection.
- Factory sealed contacts rated for heavy duty NEMA A600/Q300 explosion-protected operation.
- Comprehensive selection of operators:
 - Push buttons, standard or mushroom caps, momentary & maintained action for multiple function or emergency stop.
 - Rotary selector switches, maintained or momentary operation.
 - Pilot lights, multiple voltage & color (LED standard).
- Multiple options for various enclosure entry types and legend plates.

Index

Pg. 2Overview
3Assembled Stations
4Enclosures & Accessories
5Operators & Contact Blocks
6	...Custom Ordering & Enclosure Dims.
7Operator Dims.





Factory Sealed
Contact Block
1N.O./1N.C.

Class I, Div. 2, Groups A,B,C,D
Class I, Zone 2, Groups IIC, IIB, IIA
NEMA 3, 4, 4X, 7 (Div.2)



FEATURES-SPECIFICATIONS

Applications

Hazardous and corrosive environments such as refineries, chemical plants, water treatment and bio gas plants, and wherever a combustible gas-air mixture may occur.

Features

- Enclosures and operators of rugged polyester resin and gasketed for NEMA 4X hose down protection
- Factory sealed contacts rated for heavy duty NEMA A600/Q300 explosion-protected operation
- No external seals required for most applications
- Comprehensive selection of control operators including:
 - Push buttons (standard or mushroom caps) with momentary & maintained action for multiple functions or emergency stop
 - Rotary selector switches for maintained or momentary operation
 - Pilot lights (LED as standard) in multiple voltages and colors
- Options for various enclosures entry types and legend plates
- Gaskets of Neoprene/EPDM types and legend plates
- Cover screws (captivated) of 316 Stainless Steel

PRODUCT LINE OVERVIEW

ASSEMBLIES



One device



Two devices



Three devices

CONTROL DEVICES

Push Button

Shrouded or mushroom style

Maintained push-pull or twist-release button



Control Switch

Multiple position rotary maintained or momentary action



Pilot Light

Full voltage, resistor or transformer and multi-voltage LED types



ENCLOSURES



Size 1



Size 2



ENTRIES AND ACCESSORIES



Hub with
Grounding locknut



Legend
Plates



Hole Plug



Lockouts



D2CG2B2



D2CG2MMR3



D2CG2S3C3



D2CG2B7



D2CG8B15

The control stations on this page are the most commonly used configurations, including combinations of push buttons, pilot lights and selector switches. See the following pages for components to configure custom stations.

FEATURES-SPECIFICATIONS

ONE DEVICE, DEAD END ^①													
Single Push Button (Momentary Contact)													
Complete Units (Box & Cover)	NPT SIZE	DIAGRAM	COLOR	LEGEND ^②									
D2CG2B1	3/4"		GREEN	START									
D2CG2B2			RED	STOP									
D2CG2B3			BLACK	BLANK									
Push-Pull Mushroom Button (Maintained Contact)													
D2CG2MMR3	3/4"		RED	EMERGENCY STOP									
Pilot Light (120V AC Light Emitting Diode Type)													
D2CG2B24CL	3/4"		CLEAR	BLANK									
D2CG2B24GL			GREEN	BLANK									
D2CG2B24RL			RED	BLANK									
D2CG2B24BL			BLUE	BLANK									
D2CG2B24AL			AMBER	BLANK									
D2CG2B24WL			WHITE	BLANK									
2 Position Rotary Selector Switch (Maintained Contact)													
D2CG2S2A3	3/4"	<table border="0"> <tr> <td>LEFT</td> <td>DIAGRAM</td> <td>RIGHT</td> </tr> <tr> <td></td> <td>CENTER</td> <td></td> </tr> <tr> <td></td> <td>—</td> <td></td> </tr> </table>	LEFT	DIAGRAM	RIGHT		CENTER			—		OFF - ON	
LEFT	DIAGRAM	RIGHT											
	CENTER												
	—												
3 Position Rotary Selector Switch (Maintained Contact)													
D2CG2S3C3	3/4"	<table border="0"> <tr> <td></td> <td></td> <td></td> </tr> </table>				HAND-OFF-AUTO							

TWO DEVICES, DEAD END ^①				
Two Push Buttons (Both Momentary Contact)				
Complete Units (Box & Cover)	NPT SIZE	DIAGRAM	COLOR	LEGEND ^②
D2CG2B4	3/4"		GREEN - RED	START - STOP
D2CG2B7			BLACK - BLACK	BLANK
Pilot Light (120V AC Light Emitting Diode Type) and Push Button (Momentary Contact)				
D2CG2B13	3/4"		RED LENS, BLACK BUTTON	BLANK

THREE DEVICES, DEAD END ^①				
Pilot Light (120V AC Light Emitting Diode Type) and two push buttons (Both Momentary Contact)				
Complete Units (Box & Cover)	NPT SIZE	DIAGRAM	COLOR	LEGEND ^②
D2CG8B15	3/4"		RED LENS, GREEN & RED BUTTONS	BLANK, START, STOP
Three Push Buttons (Each Momentary Contact)				
D2CG8B9	3/4"		GREEN, RED & BLACK BUTTONS	START, STOP, BLANK

^①For 3/4" FEED-THRU, change G2 or G8 in catalog number to G5. Example D2CG2B1 becomes D2CG5B1. For other hub sizes, see page C4.

^②Specify pilot light lens marking or blank button marking if required.





FEATURES-SPECIFICATIONS

SIZE 1 BOXES

Catalog Number	Description
PWBG0	Blank - No Entries
PWBG1	w/1/2" NPT hub, dead end
PWBG2	w/3/4" NPT hub, dead end
PWBG3	w/1" NPT hub, dead end
PWBG4	w/1/2" NPT hubs, feed thru
PWBG5	w/3/4" NPT hubs, feed thru
PWBG6	w/1" NPT hubs, feed thru
PWBG25	w/clearance hole, 1/2" NPS
PWBG26	w/clearance hole, 3/4" NPS
PWBG27	w/clearance hole, 1" NPS
PWBG37	w/clearance hole, M20
PWBG38	w/clearance hole, M25
PWBG39	w/clearance hole, M32

SIZE 1 COVERS

PWCG10	Blank-no device openings
D2CCG11	w/1 device opening 30mm
D2CCG12	w/2 device openings 30mm

SIZE 2 BOXES









Catalog Number	Description
PWBG00	Blank - No Entries
PWBG7	w/1/2" NPT hub, dead end
PWBG8	w/3/4" NPT hub, dead end
PWBG9	w/1" NPT hub, dead end
PWBG10	w/1/2" NPT hubs, feed thru
PWBG11	w/3/4" NPT hubs, feed thru
PWBG12	w/1" NPT hubs, feed thru
PWBG31	w/clearance hole, 1/2" NPS
PWBG32	w/clearance hole, 3/4" NPS
PWBG33	w/clearance hole, 1" NPS
PWBG43	w/clearance hole, M20
PWBG44	w/clearance hole, M25
PWBG45	w/clearance hole, M32

SIZE 2 COVERS

PWCG20	Blank-no device openings
D2CCG23	w/3 device openings 30mm
D2CCG24*	w/4 device openings 30mm

* Space restrictions may apply for feed thru conduit entries.

ENTRY FITTINGS** & ACCESSORIES

Catalog Number	Description
 WH-1G	Hub w/grounding locknut 1/2" NPT
 WH-2G	Hub w/grounding locknut 3/4" NPT
 WH-3G	Hub w/grounding locknut 1" NPT
 YOCCHP	Hole plug for 30mm operator
 YOCLOAX	Lockout for half shroud momentary buttons
 YOCLOAM	Lockout for momentary mushroom buttons
 YOCLOAP	Lockout for maintained mushroom buttons
 YOCLOAFC	Lockout cover (clear) for buttons or switches

** For other entry openings, contact factory.

LEGEND PLATES***

Blue plate with white lettering - add to end of base catalog number YOCCLPBE. Example YOCCLPBE02.

02 = CLOSE	19 = REVERSE
03 = DOWN	20 = RUN
04 = EMERGENCY STOP	22 = START
07 = FORWARD	23 = STOP
14 = OPEN	24 = TEST
15 = POWER OFF	25 = UP
16 = POWER ON	30 = PUSH TO RESET
17 = PUSH TO TEST	56 = OFF - ON
18 = RESET	83 = HAND - OFF - AUTO



Blank plates for engraving - add to end of base catalog number YOCCLP. Example YOCCLPBE00.

BE00 = Blue Plate	WE00 = White Plate
GN00 = Green Plate	YW00 = Yellow Plate
RD00 = Red Plate	00 = Black Plate

*** contact factory for additional selections.





Push Button - Momentary



Rotary Switch



Factory Sealed
Contact Block
1 N.O./1 N.C.



Mushroom - Maintained



Pilot Light - LED

FEATURES-SPECIFICATIONS

Momentary Push Button Operators*

Catalog Number	Description
D2CO1KX3	Black Push Button Full Shroud
D2CO1GX3	Green Push Button Full Shroud
D2CO1RX3	Red Push Button Full Shroud
D2CO1KH3	Black Push Button Half Shroud
D2CO1GH3	Green Push Button Half Shroud
D2CO1RH3	Red Push Button Half Shroud
D2CO1KM3	Black Push Button Mushroom
D2CO1GM3	Green Push Button Mushroom
D2CO1RM3	Red Push Button Mushroom

Maintained Mushroom Push Button Operators*

D2COM1K3	Black Push-Pull Mushroom
D2COM1G3	Green Push-Pull Mushroom
D2COM1R3	Red Push-Pull Mushroom
D2COT1R3	Red Twist to Release Mushroom

Rotary Selector Switch Operators*

D2CO52A3	Maintained 2-Position
D2CO53C3	Maintained 3-Position
D2CO63	Momentary Right, 2-Position
D2CO73	Maintained Center 3-Position
D2CO143	Maintained Left & Center 3-Position
D2CO153	Maintained Right & Center 3-Position

* Operators supplied with one universal factory sealed 1 N.O. + 1 N.C. contact block. For operator provided with two contact blocks, change last digit (3) of catalog number to 8. For actuator only, change (3) to 0.

LED Pilot Light Devices

Add to end of base catalog number D2CO3. Example D2CO3A23.

A23	=	Amber 120V AC/DC
A4	=	Amber 24V AC/DC
AMV	=	Amber Multi-voltage 20V-254V AC/DC
B23	=	Blue 120V AC/DC
B4	=	Blue 24V AC/DC
BMV	=	Blue Multi-voltage 20V-254V AC/DC
C23	=	Clear 120V AC/DC
C4	=	Clear 24V AC/DC
CMV	=	Clear Multi-voltage 20V-254V AC/DC
G23	=	Green 120V AC/DC
G4	=	Green 24V AC/DC
GMV	=	Green Multi-voltage 20V-254V AC/DC
R23	=	Red 120V AC/DC
R25R	=	Red 480VAC/DC resistor
R25T	=	Red 480VAC transformer
R4	=	Red 24V AC/DC
RMV	=	Red multi-voltage 20V-254V AC/DC
W23	=	White frosted 120V AC/DC
W4	=	White frosted 24V AC/DC
WMV	=	White frosted Multi-voltage 20V-254V AC/DC

Factory Sealed Contact Block

Catalog Number	Description	Diagram
D2CU (add suffix R for rotary selector switches)	Factory Sealed Contact Block 1 Normally Open and 1 Normally closed	

Hazardous Rating:

Class I, Division 2, Groups A,B,C,D; Class I, Zone 2, Groups IIB+H2, IIA, T6

Terminal Capacity:

22 thru 12 AWG [0.5-2.5mm²] copper, solid or stranded conductors.
Tightening torque 7 in.-lbs. (tolerance +3.0/0.0) [~ 0.8Nm]

Contact Electrical Ratings:

NEMA A600- 7200 VA (Make), 720 VA (Break), 10 Amps Cont. @600V AC (Thermal)
NEMA Q300- 69 VA (Make & Break), 2.5 Amps Cont. @250V DC (Thermal)



Design your own DuraTech® configuration from components by completing the following:

Box Size ¹ ² Hub Size ^{1/2} ^{3/4} ¹ Dead End Feed Thru

Clearance Hole NPS ^{1/2} ^{3/4} ¹ Metric ^{M20} ^{M25} ^{M32}

Cover Size ¹ ² Number of Devices ¹ ² ³ ⁴

Select Devices From Top (Position 1) to Bottom

Device	Nameplate	Options
Position 1 _____	_____	_____
Position 2 _____	_____	_____
Position 3 _____	_____	_____
Position 4 _____	_____	_____

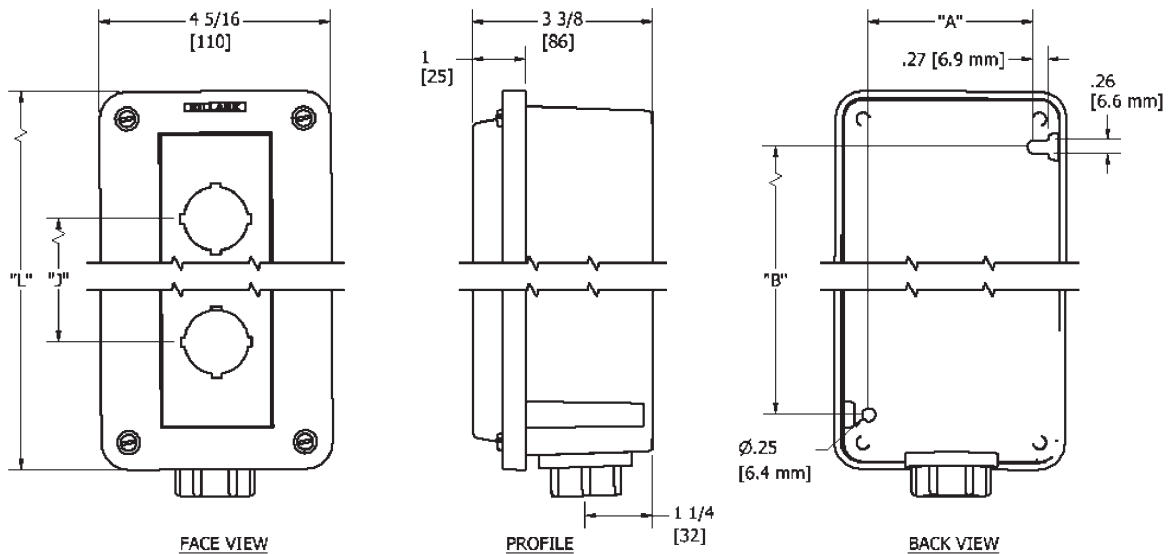

ENCL. SIZE	LENGTH "L"	DEVICE HOLES "J"	MOUNTING HOLES "A"	"B"
10		blank cover		
11	6.75 [172]	one centered hole	3.06 [78]	4.70 [120]
12		2.0 [50.8]		
20		blank cover		
23	10.36 [264]	2.19 [55.5]	3.06 [78]	8.34 [212]
24		2.06 [52.4]		



Full-Shrouded Momentary Push Button Operator

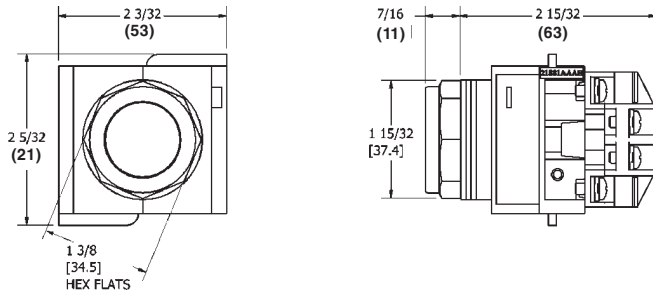

Half-Shrouded Button

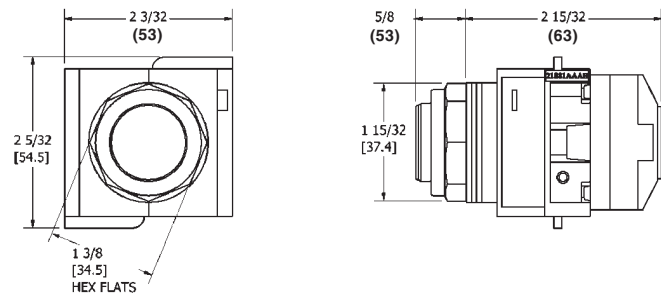

Mushroom Push Button

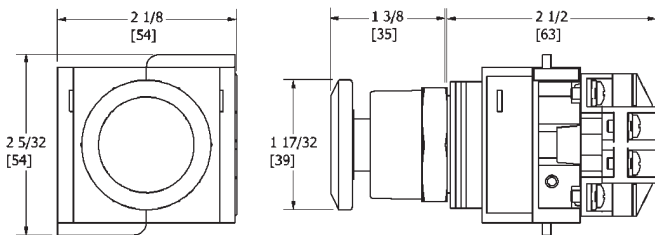

Selector Switch Device

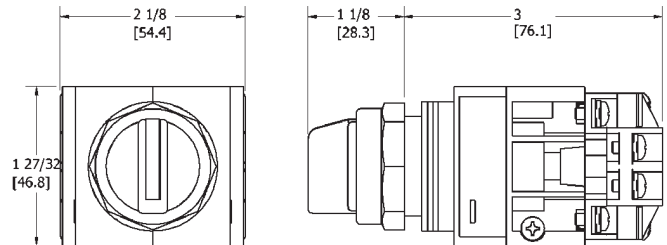

Pilot Light Multi-Voltage 20V-240V AC/DC

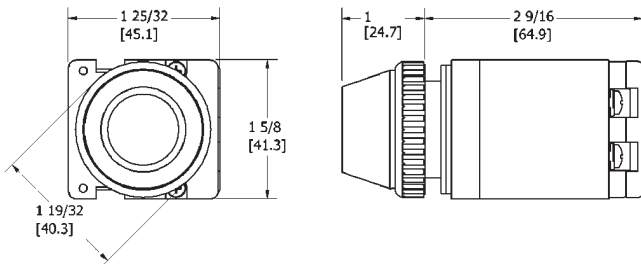

Pilot Light 120V AC (Full Voltage)

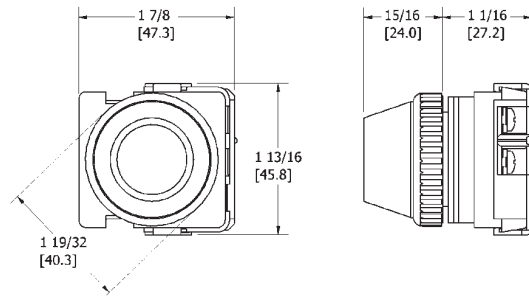

Legend Plate

